

O. Thompson Co.

Terminal Slowdown Switch Installation and Adjustment Manual

O. Thompson Co.

84-00 73rd Ave. Unit F
Glendale NY 11385
(718) 417-3131
(718) 417-9075 fax

Section 1 General Information

The O. Thompson Co. Terminal Slowdown Switch assembly is designed for installation on any O. Thompson control system. There are two models of the system, one utilizing 8 switches and one with 12 switches. The 8-switch unit is designed for cars with rated speed less than 500 feet per minute. The 12-switch unit is designed for cars with rated speeds 500 feet per minute or greater. Both the 8-switch and the 12-switch units use the same parts.

The switches have dry contacts and can accommodate 12 – 120 VAC or VDC with maximum switching current of 1 amp.

Section 2 Theory of Operation

The O. Thompson Terminal Slowdown Switch assembly is comprised of several different components. The first component is the switch box. The switch box is designed for mounting on the top of the elevator car. A mounting bracket is supplied to fasten the switch box to crosshead on the elevator.

The switch box has either 8 or 12 memory reed switches. These reed switches will activate, either opening or closing, when passing a magnet.

The next component is the actuating magnet. The actuating magnet is designed to trigger the memory reed switches. Note that there is a small backward “S” on one side of the magnet. This designates that this side is the south pole of the magnet. Refer to Figure 1 below.

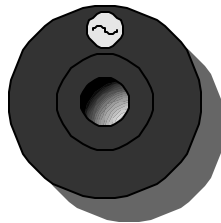

Figure 1

The system is constructed so that as the reed switch passes a south pole magnet in the down direction the switch will open. As the switch passes the same south pole magnet in the up direction it will close. This arrangement is reversed for the north pole magnets. As the reed switch passes a north pole magnet in the up direction the switch will open. As it passes it in the down direction the switch will close. The operation of the switches is not dependent on power to the switches. The switches will operate whether there is power applied to them or not.

Mounting brackets are supplied to mount the actuating magnets to the rails in the hoistway. Figure 2 shows the mounting bracket. These brackets are designed for quick installation to the rails.

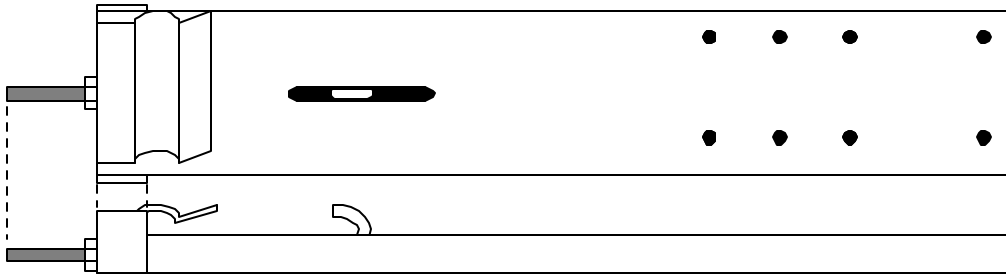

Figure 2

One end of the bracket has a J-bolt. The J-bolt is designed to clamp around the rail and pull the bracket tight against the rail. Refer to Figure 3 for J-bolt construction.

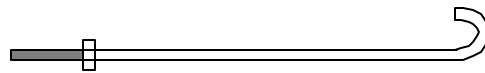

Figure 3

The next component is the aluminum channel. There are two different sized pieces of aluminum channel. One piece is approximately 15" long and is packaged with the rail bracket. This channel is designed to mount to the rail bracket. The other piece of aluminum channel is approximately 6" long and is designed to mount the magnets to the 15" channel that is installed on the rail brackets. ***The aluminum channel must be placed between the magnet and the rail bracket or the system will not operate properly.***

Section 3 Installation

Place the car level at the bottom floor. Locate an area on top of the car where the switch box will be mounted. Locate the switch box away from the traveling cables, landing system and governor rope. Fasten the switch box to the supplied mounting bracket and attach the bracket to the crosshead.

Remove the 1/4" bolts from the rail brackets. These bolts can be discarded. Mount the 15" aluminum channel to the rail bracket using the supplied allen-head screws. Refer to Figure 4 for proper mounting of the channel.

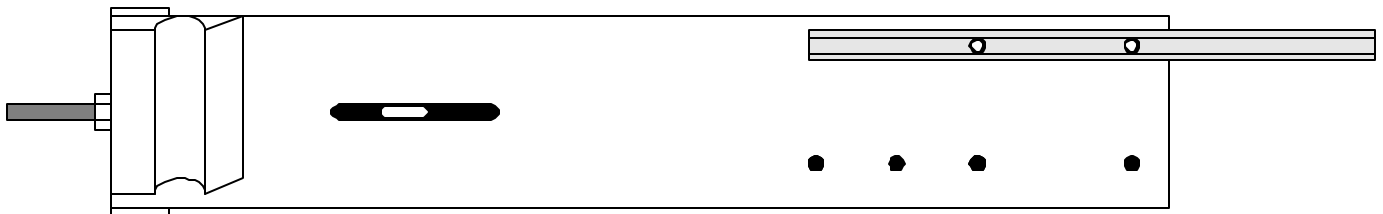

Figure 4



NOTE: *It may be desirable to mount the 15" aluminum channel on the lower set of holes in the rail bracket due to obstructions in the hoistway or fishplates on the rails.*

Measuring from the center of the reed switches on the switch box, mount one of the rail brackets to the rail for the bottom directional limit. Refer to the wiring diagrams and manual for the exact location of where the switch must open.



NOTE: *The operation of the reed switch will occur when the magnet is roughly at the center of the switch. Mount the rail bracket so that that aluminum channel is roughly centered on the switch. The exact placement will be finalized later when the magnet is installed.*

Mount the bracket to the rail and tap it in place with a hammer. Tighten the nut on the J-bolt so that the tabs at the end of the bracket are snug against the rail. **Be careful not to over-tighten the J-bolt, as the tabs on the mounting bracket may bend.** Refer to Figure 5 for proper rail bracket mounting.

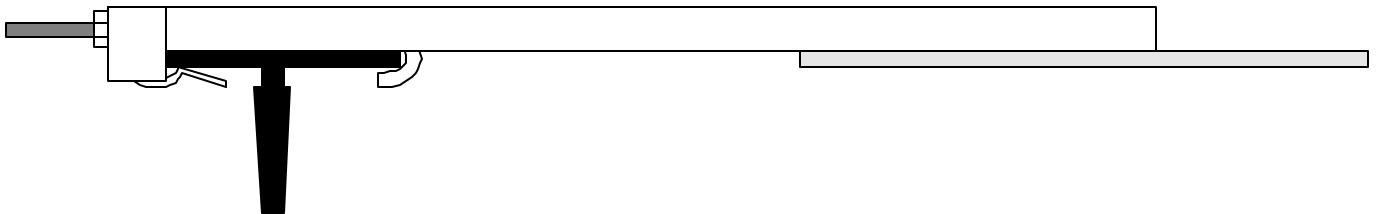

Figure 5



NOTE: *The bracket in Figure 5 may be shown opposite of the way it is mounted in the hoistway. The bracket may be located on the left or right of the rail, and the rail may be facing the opposite direction.*

Next locate one of the plastic bags containing a magnet, 6" aluminum channel, and mounting hardware. The magnet needs to be mounted to the 6" aluminum channel using the supplied #6-32 screw and square nut. Place the screw through the magnet, **south pole facing the screw head**, and place the star washer behind the magnet. Thread the square nut on to the end of the screw. **Do not tighten the screw at this time!** Refer to Figure 6 for magnet assembly.

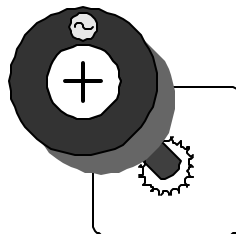

Figure 6

Locate the 1/4"-20 allen-head bolt and the 1/4"-20 square nut. Place the bolt through the center hole of the 6" aluminum channel so that the bolt head is inside of the channel. Install the square nut on the back of the channel. Do not tighten the bolt and square nut, as it will need to slide onto the 15" channel on the rail bracket.

Slide the magnet onto the 6" aluminum channel. **Make sure the star washer is between the magnet and channel.** Loosely tighten the magnet so it is about 1" away from the center of the channel.

Slide the 6" aluminum channel onto the 15" channel mounted on the rail bracket. Mount the 6" channel perpendicular to the 15" channel. Refer to Figure 7 below.

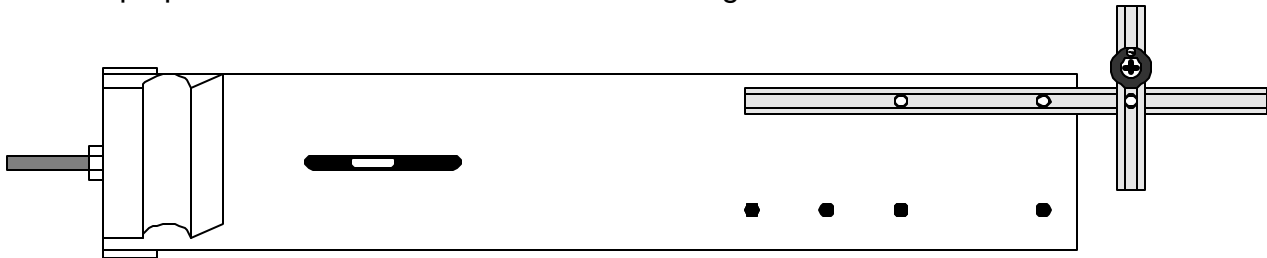

Figure 7



NOTE: *If the location of the rail bracket is close to an obstruction or a fishplate on the rail put the 1/4"-20 allen-head bolt in the hole at the end of the 6" aluminum channel so the magnet can be adjusted further away from the rail bracket. Place the magnet at the end of the 6" channel to compensate for the obstruction. Refer to Figure 8 for alternate mounting method.*

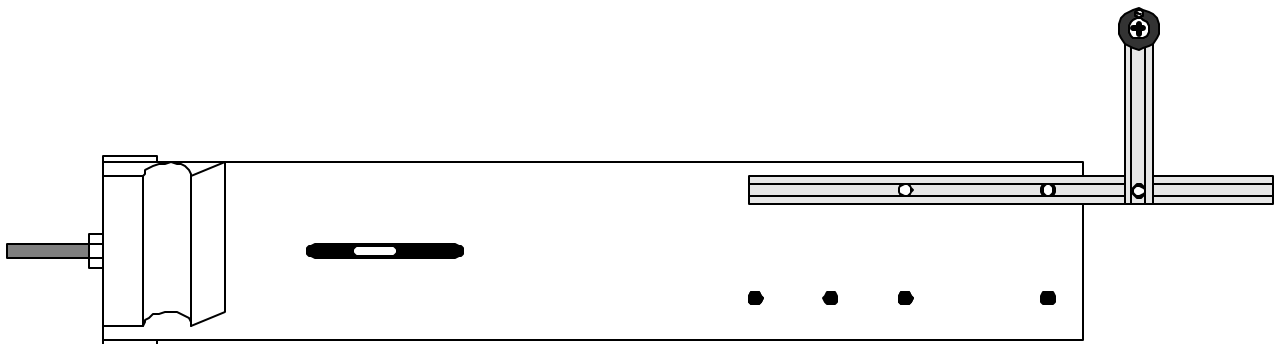

Figure 8

Adjust the channel so that the magnet is centered in place directly in front of the memory reed switch that it will be activating. In this case it is the down normal limit, so it must be placed in front of that reed switch. Refer to Figure 9 for proper alignment.

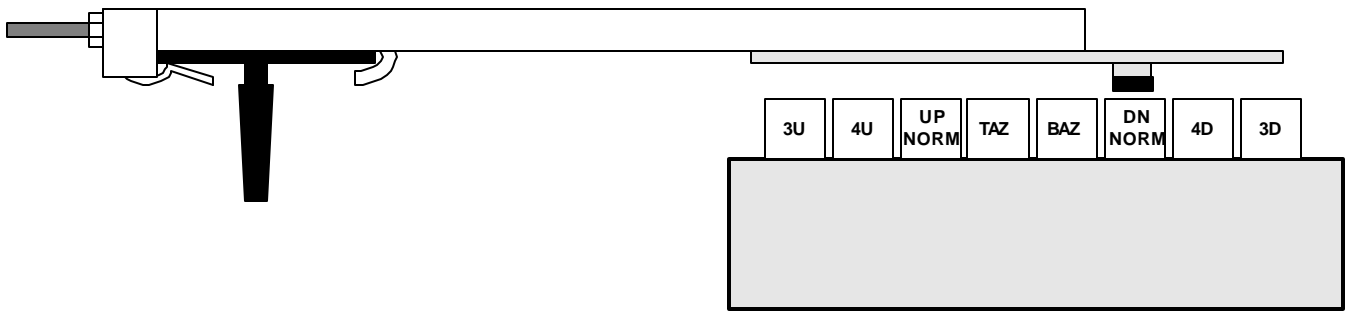

Figure 9

The switch box needs to be adjusted so that there is a minimum of $\frac{1}{4}$ " clearance between the magnets and the switches, but no greater than $\frac{3}{4}$ " clearance. There are slotted holes in the bottom of the switch box to allow the box to be adjusted front to back, as necessary.

Remove any field wires that are installed on terminals DNN1 and DNN2 of the terminal block in the switch box. Place an ohmmeter on DNN1 and DNN2. Run the car up on inspection past the magnet and then down past the magnet. Note the location of the car when the switch opens. If the opening of the switch needs to be adjusted, loosen the magnet and slide it up or down, as required.

Once the magnet is set in the desired position the installation of the down directional limit is complete. Tighten the J-bolt on the rail bracket, the allen-head screws securing the 6" channel to the 15" channel, and the bolts securing the switch box to the car top mounting bracket. Replace any wiring that was removed to check where the limit switch opened.

Referring to the wiring diagrams and the controller installation manual, check where the terminal slowdown switch closest to the bottom floor should be set. Using a tape measure, measure from the top of the down directional limit switch bracket up to the location of the next slowdown switch. Remember to allow for the distance the directional limit switch is away from floor level. For example, if the directional limit switch is set to open 1" before the floor and the slowdown switch is supposed to open 3' before the floor, measure 2' 11" up from the top of the bracket. Make a chalk mark on the rail where the bracket should be located.

Move the car up to a spot where it is convenient work on the next bracket. Mount the bracket to the rail in the same manner that was used to mount the down directional limit bracket. Remove the $\frac{1}{4}$ " screws from the bracket and mount the 15" channel to the bracket.

Next, in the same manner that was used to install the bottom directional limit, loosely mount the 6" channel to the 15" channel on the rail bracket. Mount a magnet to the 6" channel, **south pole facing the switch box**, and adjust it so that the magnet is directly in front of the reed switch that it will be activating.

Tighten the J-bolt on the rail bracket, the allen-head screws securing the 6" channel to the 15" channel, and the magnet securing screw.

Repeat the above steps until all of the down slowdown brackets and magnets are installed. **All of the down direction slowdown magnets should have the south pole facing the switch box.**

If the control system has hoistway access place the car where it should stop in the up direction when running from the bottom access key switch. Install a bracket on the rail with the top of the bracket centered on the reed switches. Install the 15" channel to the bracket. Install a magnet, **north pole facing the switch box**, onto a piece of 6" aluminum channel. Install the 6" channel onto the 15" channel and adjust the magnet so that it is centered in place directly in front of the "BAZ" reed switch. Refer to Figure 10 for the locations of the switches on the 8-switch unit, and Figure 11 for the locations of the switches on the 12-switch unit.

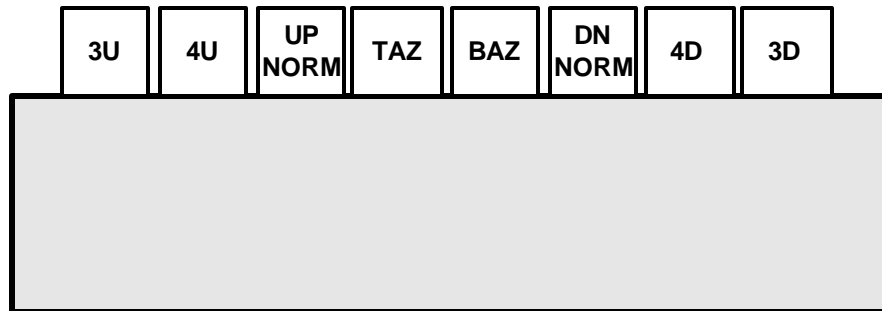

Figure 10

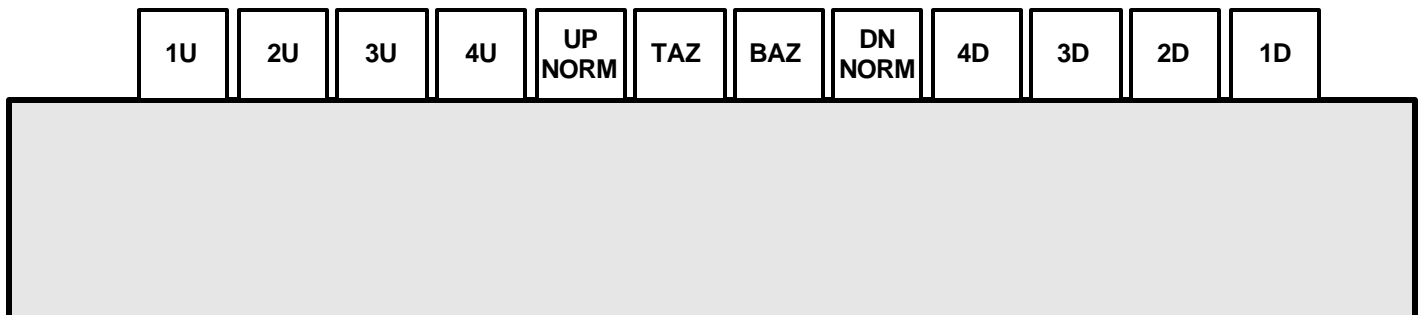

Figure 11

Once all of the down slowdown brackets and magnets are installed it is necessary to install the top brackets and magnets. Run the car to the top floor and place it level with the floor. Referring to the wiring diagrams and installation manual for the control system, measure from the center of the reed switches and mount one of the rail brackets to the rail for the top directional limit. Remember that the switch will open when the magnet is roughly in the center of the switch, so mount the bracket to the rail and place the 6" aluminum channel so that the magnet will be located the correct distance from the floor for the directional limit switch.

Install a magnet onto one of the square nuts, **north pole facing the switch box**, and slide it onto the 6" aluminum channel. Adjust the magnet so that it is centered in place directly in front of the up directional reed switch.

Remove any field wires that are installed on terminals UPN1 and UPN2 of the terminal block in the switch box. Place an ohmmeter on UPN1 and UPN2. Run the on inspection down past the magnet and then up past the magnet. Note the location of the car when the switch opens. If the opening of the switch needs to be adjusted, loosen the magnet fastening screw and slide the magnet up or down as required.

The installation of the up directional limit is complete. Tighten the J-bolt on the rail bracket; the allen-head bolt securing the 6" channel to the 15" channel and the magnet securing screw as necessary. Replace any wiring that was removed to check where the limit switch opened.

Referring to the wiring diagrams and the controller installation manual, check where the terminal slowdown switch closest to the top floor should be set. Using a tape measure, measure from the top of the up directional limit switch bracket down to the location where the next slowdown rail bracket will be placed. Remember to allow for the distance the directional limit switch is away from floor level. For example, if the directional limit switch is set to open 1" before the floor and the slowdown switch is supposed to open 3' before the floor, measure 2' 11" down from the top of the bracket. Make a chalk mark on the rail where the bracket should be located.

Move the car down to a spot where it is convenient to work on the next bracket. Mount the bracket to the rail and mount the 15" channel to the bracket. Mount the 6" channel to the 15" channel and then mount a magnet to the 6" channel, **north pole facing the switch box**. Adjust the magnet so it is centered in place directly in front of the reed switch that it will be activating.

Repeat the above steps until all of the up slowdown brackets and magnets are installed. **All of the up direction slowdown magnets should have the north pole facing the switch box.**

If the control system has hoistway access place the car where it should stop in the down direction when running from the top access key switch. Install a bracket on the rail so that the 15" aluminum bracket is approximately centered on the reed switches. Install a magnet **south pole facing the switch box**, onto the 6" aluminum channel and mount it to the 15" channel so that the magnet is centered in place directly in front of the "TAZ" reed switch.

The installation of the O. Thompson Terminal Slowdown Switch assembly is complete. For correct wiring of the system refer to the wiring diagrams supplied with the controller and the wiring diagrams on the last page of this manual.

If you have any questions about this or any other O. Thompson product please contact our Technical Support Department at (718) 417-3131.

Switch Wiring

8 Switch Unit

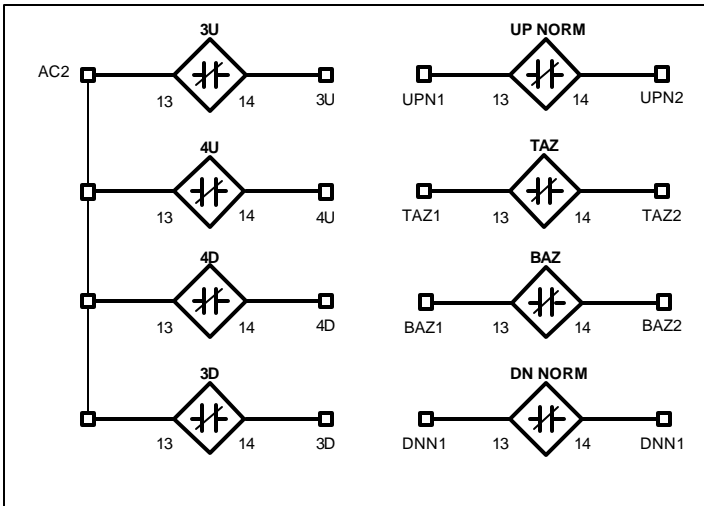

12 Switch Unit

